



1 Mufle 4ALL H92

Mufle 4ALL: excellent performance for everyone

Mufle 4ALL is the ENTRY LEVEL range produced by MUFLE, equipped with all the features necessary to obtain safe and efficient drainage.

The smooth and waterproof surface, the lightness, the special compact geometry and the guaranteed performances for the load classes A15 and B125, are the main features that make the **Mufle 4ALL** range unique in its kind.

The range includes two different heights: the **4ALL** with 90mm internal height and the new arrival **Mufle 4ALL H50** with the new internal dimension of 30mm height. Thanks to these solutions, the **Mufle 4ALL** range can be installed and put into operation in a simple and easy way, without the help of special professional equipment, and this is precisely what makes it a product for everyone.

The gratings are fixed to the channel through a mechanical system with hooks, that do not require the use of bolts or nuts or special tools; an innovation that definitely simplifies the most traditional fixing systems.

The different models of **Mufle 4ALL** can all claim of being CE marked, answering in this way to all the requirements of the European reference standard EN1433.

To protect and guarantee the declared and expected performance throughout its useful life in operation, the entire production chain is subject to strict quality controls that go well beyond those indicated as “minimum” by legislation.



Typical Applications

- Green areas
- Pedestrian areas and cycle paths
- Terraces and balconies

Mufle 4ALL H92 system overview

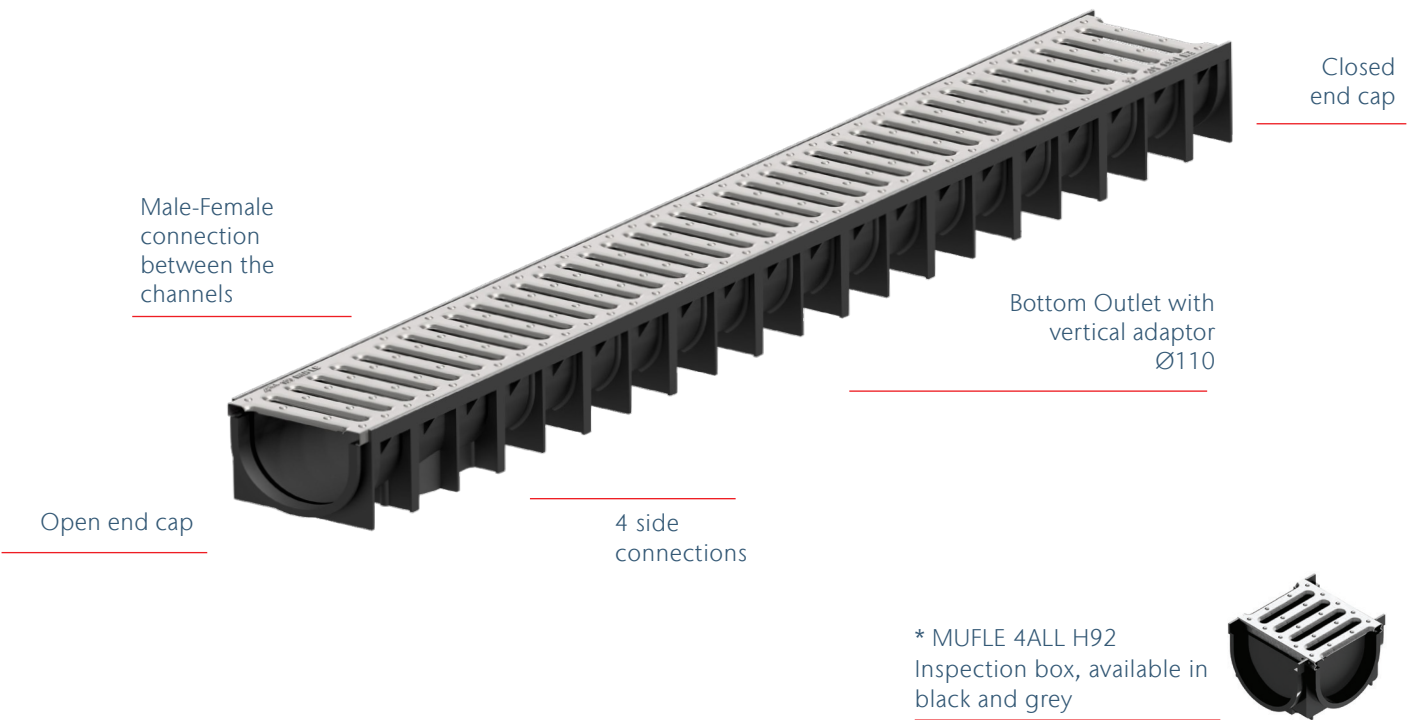

The perfect solution for your outdoor areas



Mufle 4ALL H92 channel body combined with SlotTop H40 (available also for Mufle 4ALL H50)

Functional system and minimal design

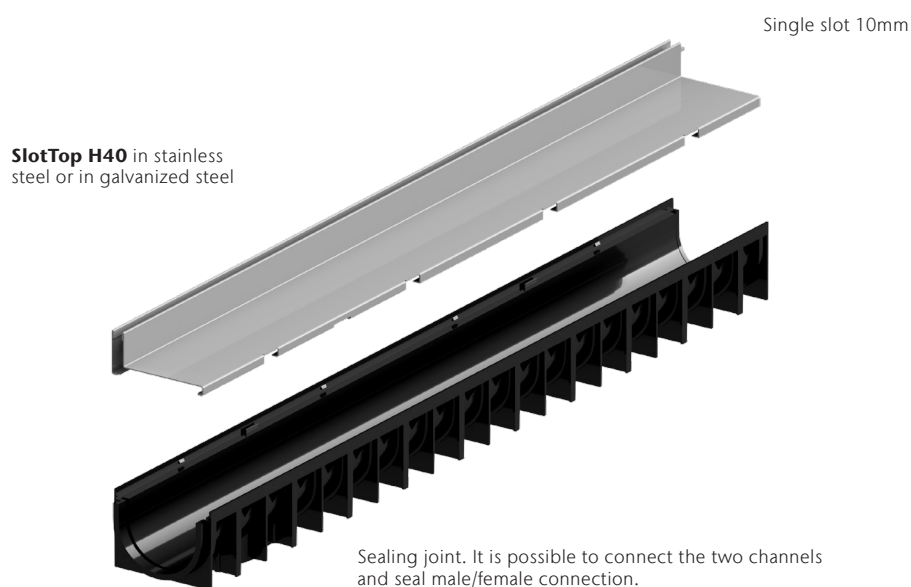

SlotTop H40
Stainless steel
Galvanized steel



Main characteristics and advantages

- Drainage system composed by Mufle 4ALL channel and SlotTop H40 grating
- Stainless steel grade AISI 304 and galvanized steel
- Slot dimension 10mm
- Suitable for paved surfaces with max 30mm thick tiles, stones
- Inspection elements: linear, with right curve or with left curve
- SlotTop H40 grating and Mufle 4ALL H50 channel can create a 90° corner without interruption on the drainage line
- Certified in accordance to EN 1433: load class B125
- Total height Mufle 4ALL H50 and SlotTop H40 : 90mm
- Total height Mufle 4ALL H92 and SlotTop H40 : 132mm
- Easy to install and transport



Mufle 4ALL H92, Black

Product information

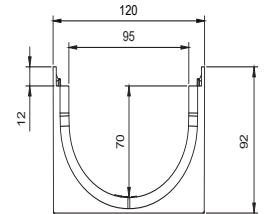
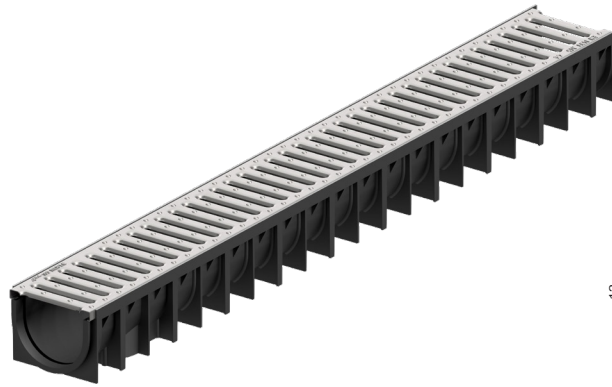

- PP-PE channel BLACK
- Channel internal size (WxH): 95 x 70 mm
- PP-PE rail
- Gratings load classes A 15, B 125
- Built-in fixing system
- Available in Black and Grey color

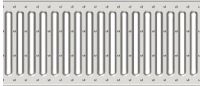
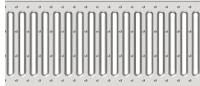

Mufle 4ALL H92 **combined with** design gratings

Image	Description	Slot [mm]	Width [mm]	Length [mm]	Height [mm]	Weight [Kg]	Pc/Pal [n.]	Article number
A15								
	Galvanized steel SLIM	5	120	1000	90	2,05	72	613038
	Stainless steel SLIM	5	120	1000	90	2,10	72	613040
B125								
	Ductile iron BROOKLYN	8	120	1000	90	5,50	72	613035
	PP-GF MANHATTAN	6	120	1000	90	2,75	72	613033

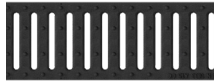
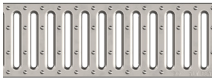
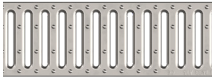
Mufle 4ALL H92 **combined with** standard gratings

Image	Description	Slot [mm]	Width [mm]	Length [mm]	Height [mm]	Weight [Kg]	Pc/Pal [n.]	Article number
A15								
	PP-PE	8	120	1000	90	1,50	72	613005
	Galvanized steel	8	120	1000	90	1,85	72	613000
	Stainless steel	8	120	1000	90	2,10	72	613016
B125								
	Ductile iron 6mm slot	6	120	1000	90	5,80	72	613030

Mufle 4ALL H92 Black inspection box

- It allows to add a side knockout to the channel
- It allows to make cross, "T" and "L" couplings

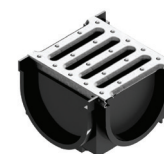

Grating Type	Load Class	Dimensions				Pc/Box [n.]	Artic. Num.
		Slot [mm]	Length [mm]	Width [mm]	Height [mm]		
PP-PE	A 15	8	145	120	92	20	613201
Galvanized steel	A 15	8	145	120	92	20	613200
Stainless steel	A 15	5	145	120	92	20	613204
Ductile iron	A 15	8	145	120	92	20	613206
DESIGN GRATING Galvanized steel SLIM	A 15	5	145	120	92	20	613207
DESIGN GRATING Stainless steel SLIM	B 125	6	145	120	92	20	613209

Mufle 4ALL H92 Black accessories

Description	Pc/Box [n.]	Artic. Num.
2 End Caps 100/70 + 1 Bottom Outlet Ø 110&75	50	513200
2 End Caps 100/70	50	513203
Bituminous sealant for PP-PE channels	1	500345



Mufle 4ALL H92, Grey

Product information

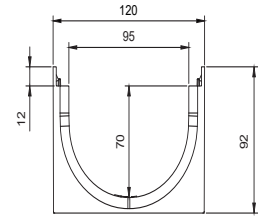
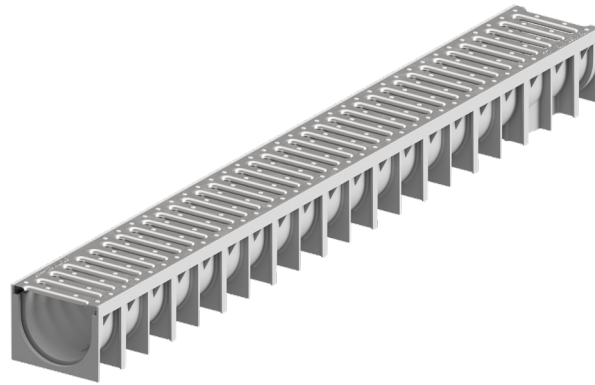

- PP-PE channel GREY
- Channel internal size (WxH): 95 x 70 mm
- PP-PE rail
- Gratings load classes A 15, B 125
- Built-in fixing system
- Available in Black and Grey color

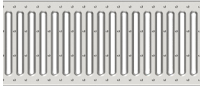
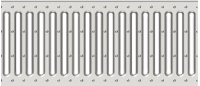

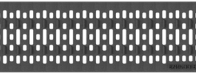
Mufle 4ALL H92 **combined with** design gratings

Image	Description	Slot [mm]	Width [mm]	Length [mm]	Height [mm]	Weight [Kg]	Pc/Pal [n.]	Article number
A15								
	Galvanized steel SLIM	5	120	1000	90	2,05	72	613039
	Stainless steel SLIM	5	120	1000	90	2,10	72	613041
B125								
	Ductile iron BROOKLYN	8	120	1000	90	5,50	72	613047
	PP-GF MANHATTAN	6	120	1000	90	2,75	72	613048

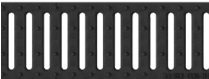
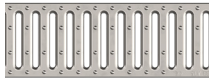
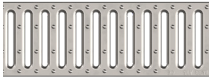
Mufle 4ALL H92 **combined with** standard gratings

Image	Description	Slot [mm]	Width [mm]	Length [mm]	Height [mm]	Weight [Kg]	Pc/Pal [n.]	Article number
A15								
	PP-PE	8	120	1000	90	1,50	72	613006
	Galvanized steel	8	120	1000	90	1,85	72	613015
	Stainless steel	8	120	1000	90	2,10	72	613022
B125								
	Ductile iron 6mm slot	6	120	1000	90	5,80	72	613042

Mufle 4ALL H92 Grey inspection box

- It allows to add a side knockout to the channel
- It allows to make cross, "T" and "L" couplings



Grating Type	Load Class	Dimensions				Pc/Box [n.]	Artic. Num.
		Slot [mm]	Length [mm]	Width [mm]	Height [mm]		
PP-PE	A 15	8	145	120	92	20	613202
Galvanized steel	A 15	8	145	120	92	20	613203
Stainless steel	A 15	5	145	120	92	20	613205
Ductile iron	A 15	8	145	120	92	20	613211
DESIGN GRATING Galvanized steel SLIM	A 15	5	145	120	92	20	613208
DESIGN GRATING Stainless steel SLIM	B 125	6	145	120	92	20	613210

Mufle 4ALL H92 Grey accessories

Description	Pc/Box [n.]	Artic. Num.
2 End Caps 100/70 + 1 Bottom Outlet Ø 110&75	50	513205
2 End Caps 100/70	50	513206
Bituminous sealant for PP-PE channels	1	500345

Mufle 4ALL H92 channel body and SlotTop H20

Product information

- PP-PE channel 4ALL H92 and SlotTop H20
- SlotTop H20 in stainless steel AISI 304 (on request AISI 316)
- Load class A15
- Slot dimension 10mm
- Elements of inspection: linear
- Total height 112mm

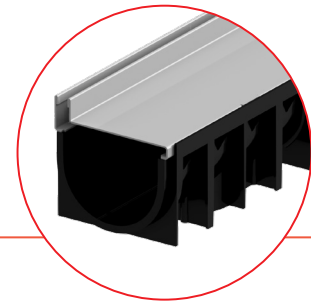
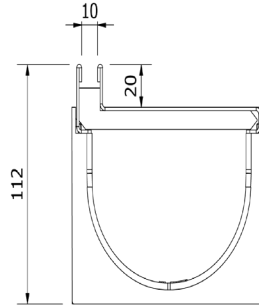

Mufle 4ALL H92 channel with SlotTop H20

	Material	Dimensions			Slot [mm]	Weight [kg]	Artic. Num
		Lenght	Widht	Height			
		[mm]	[mm]	[mm]			
	Stainless steel	1000	120	112	10	3,10	613310
with inspection element 	 Stainless steel	1000	120	112	10	3,30	613311



Mufle 4ALL H92 channel body and SlotTop H40

Product information

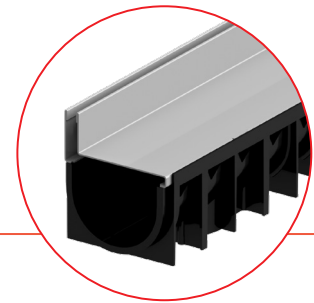
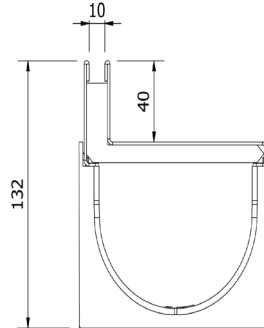
- PP-PE channel 4ALL H92 and SlotTop H40
- SlotTop H40 in stainless steel or galvanized steel
- Load class B125
- Slot dimension 10mm
- Elements of inspection: linear
- Total height 132mm

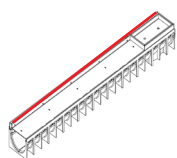

Mufle 4ALL H92 channel with SlotTop H40

	Material	Dimensions			Slot [mm]	Weight [kg]	Artic. Num
		Lenght	Widht	Height			
		[mm]	[mm]	[mm]			
	Galvanized steel	1000	120	132	10	3,75	613320
	Stainless steel	1000	120	132	10	3,75	613330
with inspection element 	Galvanized steel	800	120	132	10	4,15	613321
	Stainless steel	800	120	132	10	4,15	613331

Mufle 4ALL H92 Garage pack, Black

Product information

- The pack contains:
num. 3 PP-PE black channels, num. 3 gratings, num. 2 end caps, num. 1 outlet and screws
- Channel internal size (WxH): 95 x 70 mm
- PP-PE rail
- Gratings load classes A 15, B 125
- Built-in fixing system

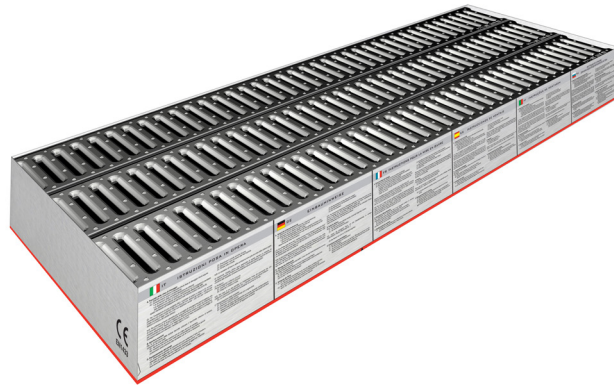

Mufle 4ALL H92 Black

Grating Type	Load Class	Slot [mm]	Dimensions			Pc/Pal [n.]	Artic. Num.
			Length [mm]	Width [mm]	Height [mm]		
PP-PE	A 15	8	1000	120	92	36	613003
Galvanized steel	A 15	8	1000	120	92	36	613001
Stainless steel	A 15	8	1000	120	92	36	613017
Ductile iron	B 125	6	1000	120	92	36	613032
DESIGN GRATING Galvanized steel SLIM	A 15	5	1000	120	92	36	613031
DESIGN GRATING Stainless steel SLIM	A 15	5	1000	120	92	36	613037
DESIGN GRATING Ductile iron BROOKLYN	B125	8	1000	120	92	36	613054
DESIGN GRATING PP-GF MANHATTAN	B125	6	1000	120	92	36	613034

Mufle 4ALL H92 Black accessories

Description	Pc/Box [n.]	Artic. Num.
2 End Caps 100/70 + 1 Bottom Outlet Ø 110&75	100	513200
2 End Caps 100/70 + 1 Bottom Outlet Ø 110&75	100	513203
Bituminous sealant for PP-PE channels	1	500345

Mufle 4ALL H92 Garage pack, Grey

Product information

- The pack contains:
num. 3 PP-PE grey channels, num. 3 gratings, num. 2 end caps, num. 1 outlet and screws
- Channel internal size (WxH): 95 x 70 mm
- PP-PE rail
- Gratings load classes A 15, B 125
- Built-in fixing system



Mufle 4ALL H92 Grey

Dimensions

Grating Type	Load Class	Slot [mm]	Dimensions			Pc/Pal [n.]	Artic. Num.
			Length [mm]	Width [mm]	Height [mm]		
PP-PE	A 15	8	1000	120	92	36	613007
Galvanized steel	A 15	8	1000	120	92	36	613008
Stainless steel	A 15	8	1000	120	92	36	613020
Ductile iron	B 125	6	1000	120	92	36	613019
DESIGN GRATING Galvanized steel SLIM	A 15	5	1000	120	92	36	613043
DESIGN GRATING Stainless steel SLIM	A 15	5	1000	120	92	36	613044
DESIGN GRATING Ductile iron BROOKLYN	B125	8	1000	120	92	36	613102
DESIGN GRATING PP-GF MANHATTAN	B125	6	1000	120	92	36	613103

Mufle 4ALL H92 Grey accessories

Description	Pc/Box	Artic. Num.
	[n.]	
2 End Caps 100/70 + 1 Bottom Outlet Ø 110&75	100	513205
2 End Caps 100/70	100	513206
Bituminous sealant for PP-PE channels	1	500345